

2009

WWW.HADEF.DE



Aluminium Gantry Cranes 
and Accessories

HADEF[®]







DET NORSKE VERITAS MANAGEMENT SYSTEM CERTIFICATE

Certificate No.: 19945-2008-AQ-GER-TGA

This is to certify that

HADEF®  **HEINRICH DE FRIES GMBH
HEBEZEUGE · WINDEN · KRANE**

Gauss Str. 20
40235 Düsseldorf - Germany

has been found to conform to the Management System Standard

ISO 9001:2000

This certificate is valid for the following product or service ranges:

**Development, production, marketing and service of
hoists, winches, trolleys and cranes for manual, electric,
hydraulic or pneumatic operation in compact,
low or ultralow headroom configuration up to 75 ton capacity**

Initial Certification date:
30.08.1994

This certificate is valid until:
24.01.2011

The audit has been performed under the supervision of

Juergen Weißbauer
Lead Auditor



Deutscher
Akreditierungs
rat
TGA-ZM-04-92-00

Place and date:
Essen, 04.02.2008

for the accredited Unit:
DNV ZERTIFIZIERUNG UND UMWELTDEUTSCHER GMBH





Nikolaus Kim
Management Representative

Lack of fulfillment of conditions as set out in the Certification Agreement may render this Certificate invalid.
DNV Zertifizierung und Umweltgüterer GmbH, Schieringhof 14, 45329 Essen, Tel.: +49 201 7296 300 Fax: +49 201 7296 333 - www.dnv.de/zertifizierung













Schweißtechnische Lehr- und Versuchsanstalt SLV Duisburg - Niederlassung der GSI mbH
Certificate Class E
Qualification of the manufacturer for welding steel structures according to DIN 18800-7: 2008-11

It is hereby certified that the firm	HEINRICH DE FRIES GmbH
have at one's disposal in the welding plant	40235 Düsseldorf, Gauss-Str. 20
the required personnel and equipment to carry out welding works for manufacturing load bearing steel structures in the following fields of application:	
Standards/Regulations	DIN 18800-7 DIN 15018 DIN 4132
Welding Processes <small>(Reference No. acc. to DIN EN ISO 4063)</small>	111 – Manual metal arc welding 135 – Metal active gas welding, partly and fully mechanized
Parent Metals	S235, S275, S355 according to the relevant edition of the Bauregelleiste
Extensions/Restrictions	None
Responsible Welding Coordinator <small>(Surname, First name, Date of birth, Qualification)</small>	Dipl.-Ing. Yildam, Aral, geb. am 11.11.1974, IWE (IIV)
Deputy <small>(Surname, First name, Date of birth, Qualification)</small>	Dipl.-Ing. Kroll, Karl-Heinz, geb. am 23.07.1958, IWE (IIV)
Remarks	on the reserve
Period of validity	from 30.05.2009 to 30.05.2012
Number of certificate	2009.0052a
issued on	09.09.2009 Lammers/wa
Manager of the Certification Body <small>(Name/Signature/Date)</small>	 Dipl.-Ing. Mählein
General requirements see reverse	



Schweißtechnische Lehr- und Versuchsanstalt SLV Duisburg
Niederlassung der GSI mbH
Postfach 10 12 82-41012 Duisburg (Bismarckstraße 89) 47037 Duisburg
Tel. 0203 / 3741-0 Fax 0203 / 374 12 28 Internet: www.slv-duisburg.de
Abteilung Qualitätsmanagement Fax 0203 / 3741-202

Aluminium Gantry Cranes and Accessories

Aluminium Gantry Crane with collapsible lateral stands	Page 4	
Aluminium Gantry Crane with collapsible lateral stands as well as double beam	Page 4	
Aluminium Gantry Crane, movable under load with collapsible lateral stands	Page 5	
Aluminium Gantry Crane, movable under load with collapsible lateral stands as well as double beam	Page 5	
Wheel Kit	Page 6	
Hand Winch	Page 6	
Cable System/Power Supply	Page 6	
Chain Hoist	Page 6	
Electric Chain Hoist	Page 6	
Custom-Made-Equipment	Page 7	
Custom-Made-Equipment	Page 7	



Aluminium Gantry Crane with collapsible lateral stands

incl. park-break-trolley
incl. integrated horizontal adjuster



*custom made products
on request and
on page 7*

Type	Item no.	load capacity kg	beam length		suspension point at the bolt of the trolley		width of lateral stand		adjusting range		weight kg
			A mm	B mm	C mm	D mm	E mm	beam support D mm	telescopic foot E mm		
1	2801311040	1,000	4,000	1,360 - 2,360	1,295	600	400	95			
1	2801311060	1,000	6,000	1,360 - 2,360	1,295	600	400	120			
1	2801311540	1,500	4,000	1,360 - 2,360	1,295	600	400	102			
1	2801311560	1,500	6,000	1,360 - 2,360	1,295	600	400	144			
2	2801321040	1,000	4,000	1,750 - 3,000	1,743	850	400	105			
2	2801321060	1,000	6,000	1,750 - 3,000	1,743	850	400	130			
2	2801321540	1,500	4,000	1,750 - 3,000	1,743	850	400	126			
2	2801321560	1,500	6,000	1,750 - 3,000	1,743	850	400	168			
3	2801331040	1,000	4,000	2,325 - 4,025	2,238	1,300	400	166			
3	2801331060	1,000	6,000	2,325 - 4,025	2,238	1,300	400	190			
3	2801331540	1,500	4,000	2,325 - 4,025	2,238	1,300	400	172			
3	2801331560	1,500	6,000	2,325 - 4,025	2,238	1,300	400	244			

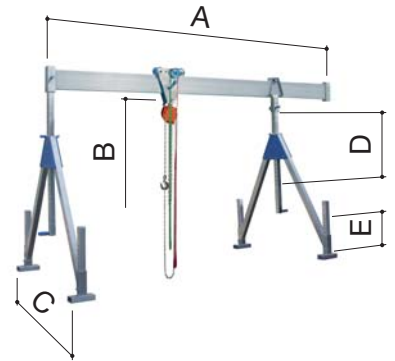

Aluminium Gantry Crane with collapsible lateral stands as well as double beam

incl. park-break-trolley
incl. integrated horizontal adjuster



*custom made products
on request and
on page 7*

Type	Item no.	load capacity kg	beam length		suspension point at the bolt of the trolley		width of lateral stand		adjusting range		weight kg
			A mm	B mm	C mm	D mm	E mm	beam support D mm	telescopic foot E mm		
1	2801511040	1,000	4,000	1,735 - 2,735	1,295	600	400	177			
1	2801511060	1,000	6,000	1,735 - 2,735	1,295	600	400	225			
1	2801511540	1,500	4,000	1,735 - 2,735	1,295	600	400	177			
1	2801511560	1,500	6,000	1,735 - 2,735	1,295	600	400	225			
2	2801521040	1,000	4,000	2,124 - 3,374	1,743	850	400	187			
2	2801521060	1,000	6,000	2,124 - 3,374	1,743	850	400	235			
2	2801521540	1,500	4,000	2,124 - 3,374	1,743	850	400	187			
2	2801521560	1,500	6,000	2,124 - 3,374	1,743	850	400	235			
3	2801531040	1,000	4,000	2,709 - 4,409	2,238	1,300	400	237			
3	2801531060	1,000	6,000	2,709 - 4,409	2,238	1,300	400	285			
3	2801531540	1,500	4,000	2,709 - 4,409	2,238	1,300	400	237			
3	2801531560	1,500	6,000	2,709 - 4,409	2,238	1,300	400	285			
2 t	2801522040	2,000	4,000	2,227 - 3,477	1,752	850	400	225			
2 t	2801522060	2,000	6,000	2,227 - 3,477	1,752	850	400	273			
3 t	2801533040	3,000	4,000	2,645 - 3,795	2,222	750	400	267			
3 t	2801533060	3,000	6,000	2,645 - 3,795	2,222	750	400	351			

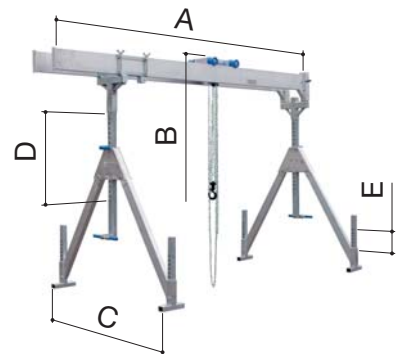

Aluminium Gantry Crane, movable under load with collapsible lateral stands

incl. park-break-trolley
incl. integrated horizontal adjuster

with 4 steel custers
- heavy-duty polyurethane lining
- with integrated castor and live ring brake

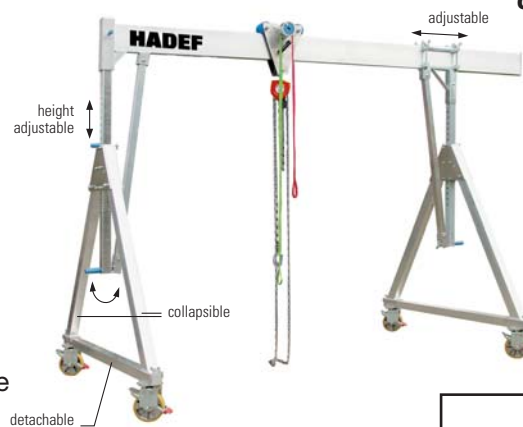

*custom made products
on request and
on page 7*



Type	Item no.	load capacity	beam length		suspension point at the bolt of the trolley		adjusting range		weight
			A	B	C	D	E		
		kg	mm	mm	mm	mm	mm	mm	kg
1	2801471040	1,000	4,000	1,720 - 2,120	1,504	400	--	--	166
1	2801471540	1,500	4,000	1,720 - 2,120	1,504	400	--	--	172
2	2801481040	1,000	4,000	2,160 - 3,010	2,012	850	--	--	192
2	2801481540	1,500	4,000	2,160 - 3,010	2,012	850	--	--	198
3	2801491040	1,000	4,000	2,490 - 3,790	2,328	1,300	--	--	214
3	2801491540	1,500	4,000	2,490 - 3,790	2,328	1,300	--	--	220

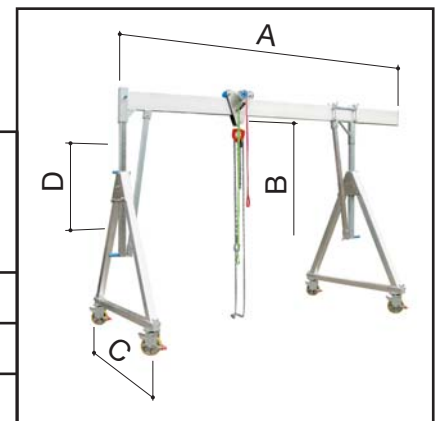

Aluminium Gantry Crane, movable under load with collapsible lateral stands as well as double beam

incl. park-break-trolley
incl. integrated horizontal adjuster

with 4 steel custers
- heavy-duty polyurethane lining
- with integrated castor and live ring brake

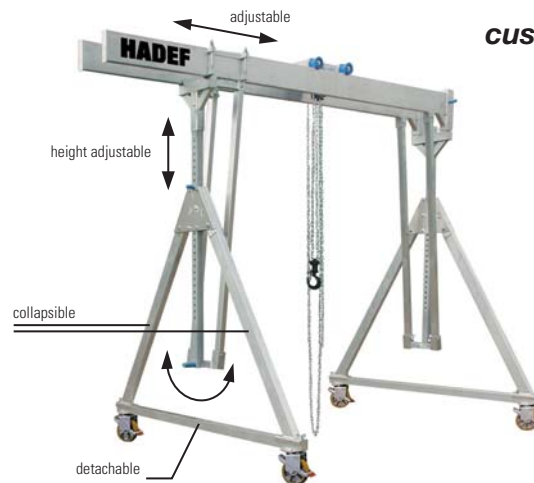

*custom made products
on request and
on page 7*

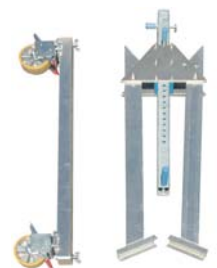

Type	Item no.	load capacity	beam length		suspension point at the bolt of the trolley		adjusting range		weight
			A	B	C	D	E		
		kg	mm	mm	mm	mm	mm	mm	kg
1	28014401040	1,000	4,000	2,100 - 2,500	1,504	400	--	--	237
1	28014401060	1,000	6,000	2,100 - 2,500	1,504	400	--	--	285
1	28014401540	1,500	4,000	2,100 - 2,500	1,504	400	--	--	237
1	28014401560	1,500	6,000	2,100 - 2,500	1,504	400	--	--	285
2	28014501040	1,000	4,000	2,540 - 3,390	2,012	850	--	--	263
2	28014501060	1,000	6,000	2,540 - 3,390	2,012	850	--	--	311
2	28014501540	1,500	4,000	2,540 - 3,390	2,012	850	--	--	263
2	28014501560	1,500	6,000	2,540 - 3,390	2,012	850	--	--	311
3	28014601040	1,000	4,000	2,875 - 4,175	2,328	1,300	--	--	285
3	28014601060	1,000	6,000	2,875 - 4,175	2,328	1,300	--	--	333
3	28014601540	1,500	4,000	2,875 - 4,175	2,328	1,300	--	--	285
3	28014601560	1,500	6,000	2,875 - 4,175	2,328	1,300	--	--	333

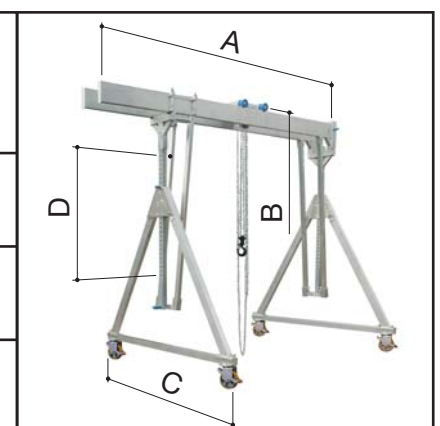



Wheel Kit



Item no. 28024002

Item no. 28024002
With heavy-duty polyurethane foam tyres
For indoor and outdoor moving of the Crane without load
Item No. 28024001
With heavy-duty polyurethane lining
For indoor moving of the Crane without load



Item no. 28024001

Facilitates the moving of the assembled Gantry Crane, without load. The spring mounted guide rolls allow the Crane's lateral stands to rest directly on the supports when under greater loads. The fork legs are individually height adjustable. The leg and fork construction permits the lateral stands to remain upright when assembling and un assembling the Crane.

Wheels: 4 steel casters with integrated wheel and live ring brake
1 Wheel Kit = 4 "forks"

The Wheel Kit is suitable for all stationary Gantry Cranes (compare page 4)

Hand Winch



- For height adjustment
- 1 set = 2 pieces (1 Hand Winch per lateral stand)
- Permits large lifting height
- The load on the crank is constant and independent of the cylinder diameter
- Durability due to the chain drive

Item no. 28059150 suitable for all Aluminium Gantry Cranes

Cable System / Power Supply

single beam

double beam



①

②

Item no. 2802509998

Item no. 2802509999

- The Crane is delivered ready-to-use including all connectors
 - Power supply 400 V / 16 Amp. 50 Hz.
 - Phase inverter CEE-connector
 - The electrical connection for the chain hoist is made using a plug and socket connection (Protection Class DIN EN 60 529 IP66)
 - All electrical components are appropriate for internal and external operating conditions
1. Item no. 2802509998 suitable for all Aluminium Gantry Cranes with single beam
 2. Item no. 2802509999 suitable for all Aluminium Gantry Cranes with double beam

Electric Chain Hoist



Chain Hoist



HADEF-Products

Special Gantry Crane

- Latest!

Combination of:

- foot (1)
- lateral extension beam (2)
- integrated cantilever (3)

With the possibility that the load can be:

- lifted
- lowered
- with the chain drive, moved along the total length of the cantilever.

In addition:

- The system is individually height adjustable.
- The lateral extension beam can be moved along the length of the cantilever.



Special Gantry Crane

- Latest!
- Extremely mobile, flexible and free-standing Crane System.
- With the trolley it is possible to reach all positions within the working area.
- Height adjustable
- Length and width adjustable
- Necessitates a highly complex construction.
- The components are nonetheless, despite the versatility and possibilities provided by the Crane, easily assembled and disassembled.

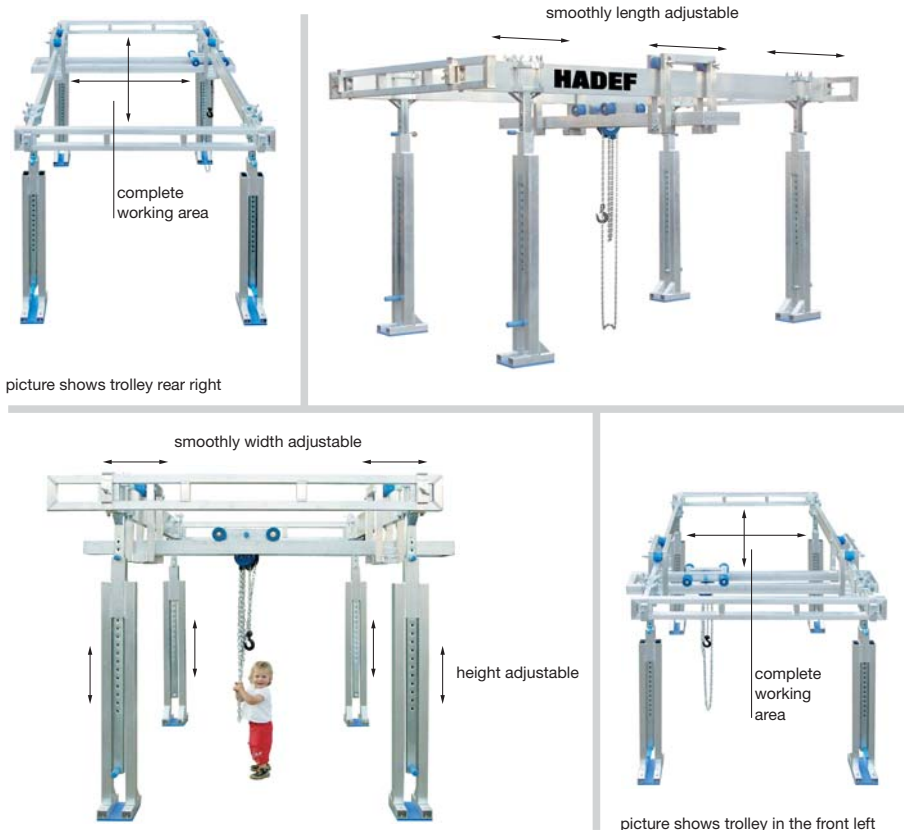



Additional interesting products from our delivery range



HADEF HEINRICH DE FRIES GmbH

Postfach 10 20 51

D-40011 Düsseldorf

Tel.: ++49 (0) 2 11-23 07 0

Fax.: ++49 (0) 2 11-23 07 209

e-mail: mail@hadeff.de

www.hadeff.de