

KABELVAGNAR, LÅNG MODELL för C-profilskena 30x32 mm Plattkabel

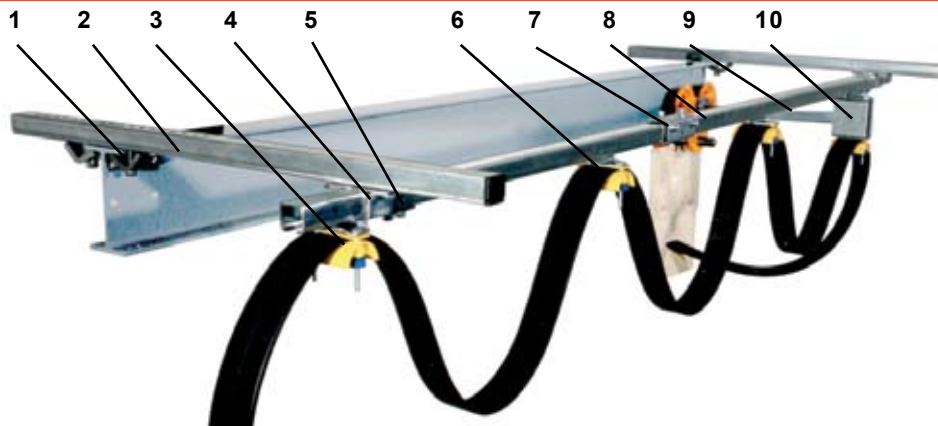

Blad 11-33 2011



1. Balkklämma
2. Konsol
3. Ändklämma
4. Takfäste
5. Ändstopp
6. Kabelvagn
7. Skarvstycke
8. C-profilskena
9. Medbringare
10. Kabelintagarvagn

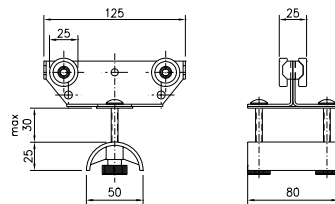

Fyrhjulig lång vagn för plattkabel

Material: Stomme av förzinkat stål
Hjul med dammtäta kullager
Kabelklämma av polyamid

Kabellast, kg: 20
Vikt, kg: 0,36
Best.nr: 11 314
E-nummer: 11 991 21

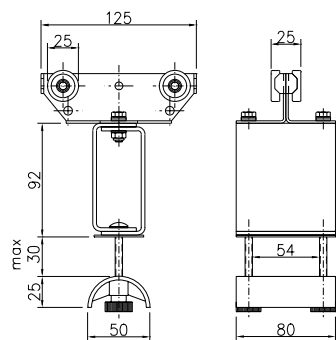

Kabelintagarvagn

Material: Stomme och intagare av förzinkat stål
Hjul med dammtäta kullager
Kabelklämma av polyamid

Kabellast, kg: 20
Vikt, kg: 0,6
Best.nr: 11 767
E-nummer: 11 991 22

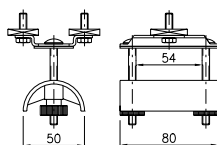

Ändklämma

Material: Polyamid, förzinkat stål

Vikt, kg: 0,2
Best.nr: 11 780
E-nummer: 11 991 24

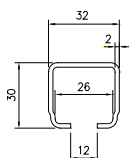

C-profilskena

Material:	Sendzimirförzinkat stål	
Längd, mm:	4000	6000
Vikt, kg:	6,2	9,3
Best.nr:	11 900	11 801
E-nummer:	11 991 05	11 991 06

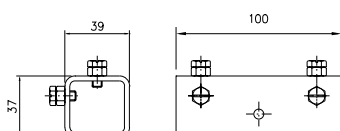

Skarvstycke

Material:	Förzinkat stål
Vi kt, kg:	0,28
Best. nr:	11 810
E-nummer:	11 991 07

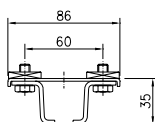

Takfäste med 4-kant mutter

Material:	Förzinkad plåt
Vikt, kg:	0,24
Best.nr:	11 820
E-nummer:	11 991 14

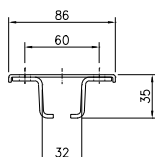

Takfäste

Material:	Förzinkad plåt
Vikt, kg:	0,16
Best.nr:	11 825
E-nummer:	11 991 17

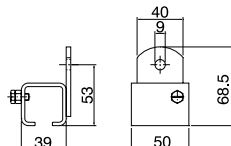

Väggfäste

Material:	Förzinkat stål
Vikt, kg:	0,20
Best.nr:	11 830
E-nummer:	11 991 18

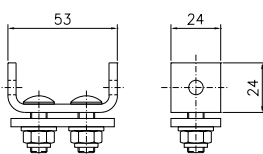

Ändstopp

Material:	Förzinkat stål
Vikt, kg:	0,13
Best.nr:	11 841
E-nummer:	11 991 16

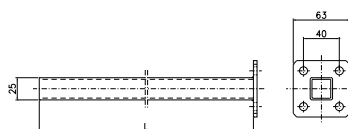

Medbringare

Material:	Förzinkat stål	
Längd, mm:	400	630
Vikt, kg:	0,6	0,8
Best.nr:	11 701	11 702
E-nummer:	11 990 35	11 990 36

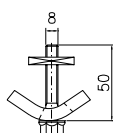

Balkklämma (2 st per konsol)

Material:	Förzinkat stål
Vikt, kg:	0,15
Best.nr:	11 737
E-nummer:	11 991 13

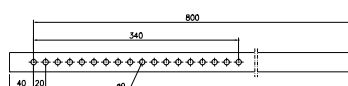

Konsol

Material:	Sendzimirförzinkat stål	
Längd, mm:	800	
Vikt, kg:	1,25	
Best.nr:	11 723	
E-nummer:	11 991 12	